

Article number: 20484M816MT
 Description: E+G T-swivel mounting
 GN 484-M8-16-MT

Measures

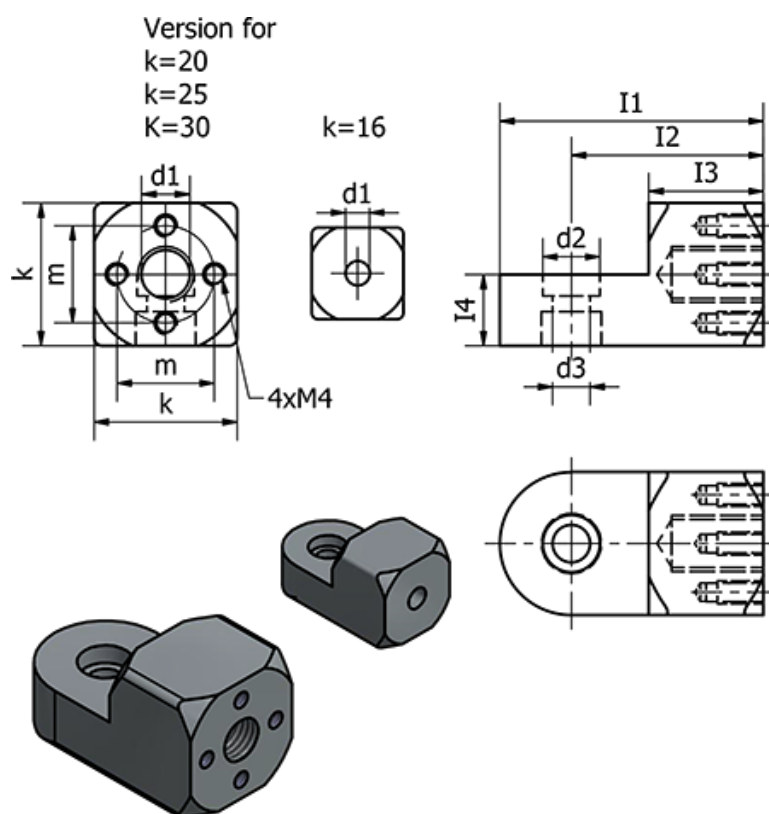

Clamping kit for d3 Type K = GN 511.1-M4-16-K

Clamping kit for d3 Type S = GN 511.1-M4-16-S

d1 = M8

d2 = 7

d3 = 4.5

I1 = 30

I2 = 22

I3 = 13

I4 = 8

k = 16

m = -

Weight (g) = 12